

Tube sauna

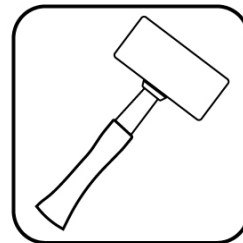

Preparations for installation

To install a tube sauna, you need the following tools:

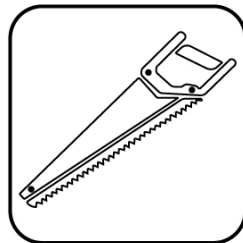
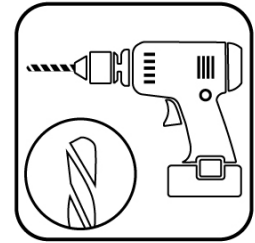
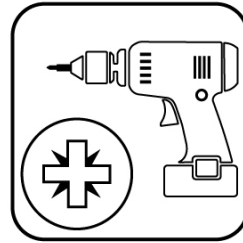
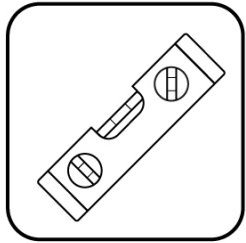
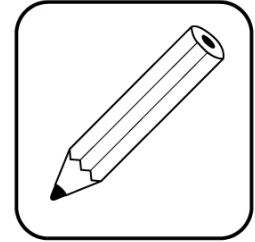
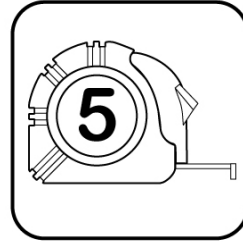
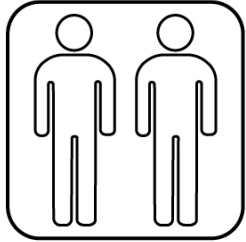

Use the level tool to install the details!

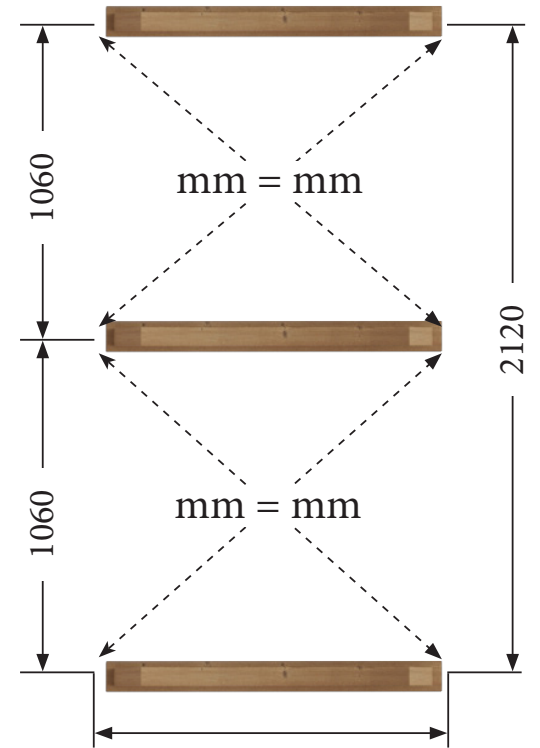
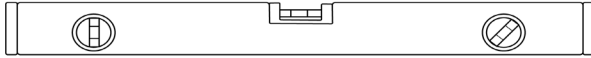

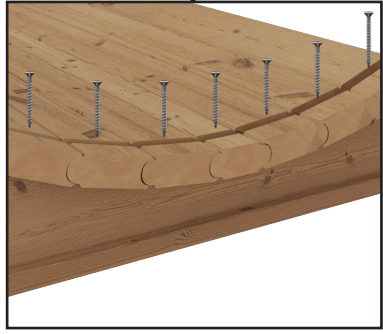
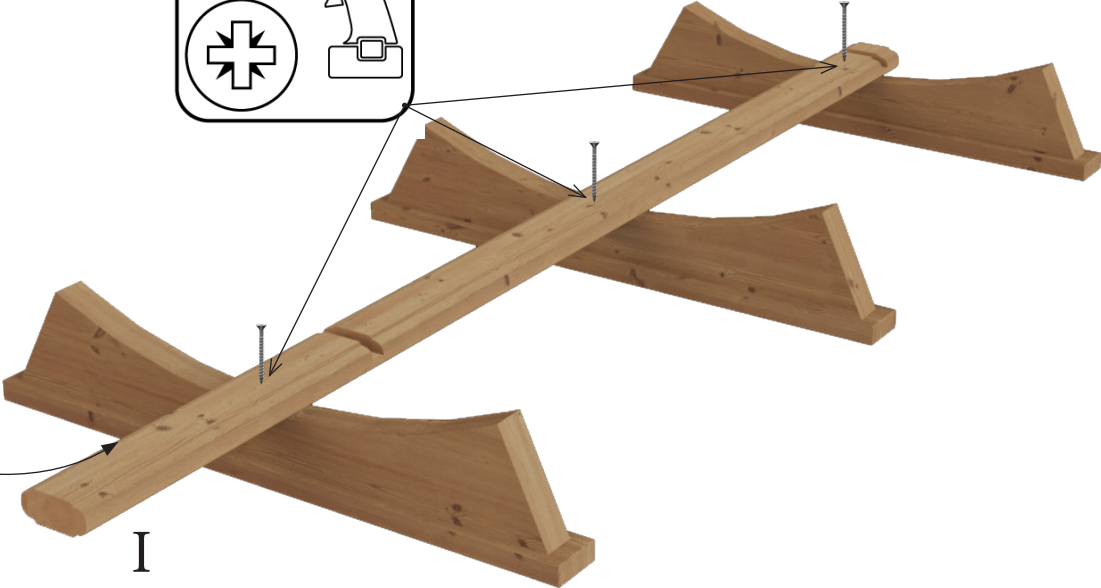
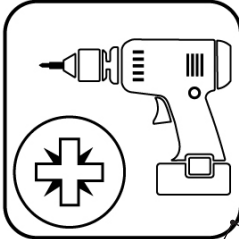
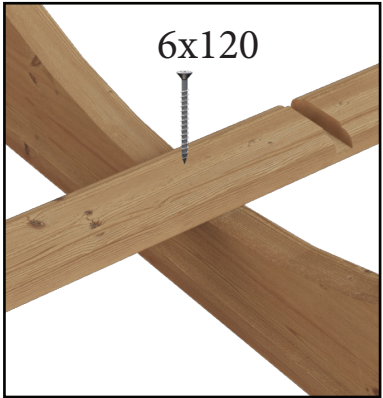

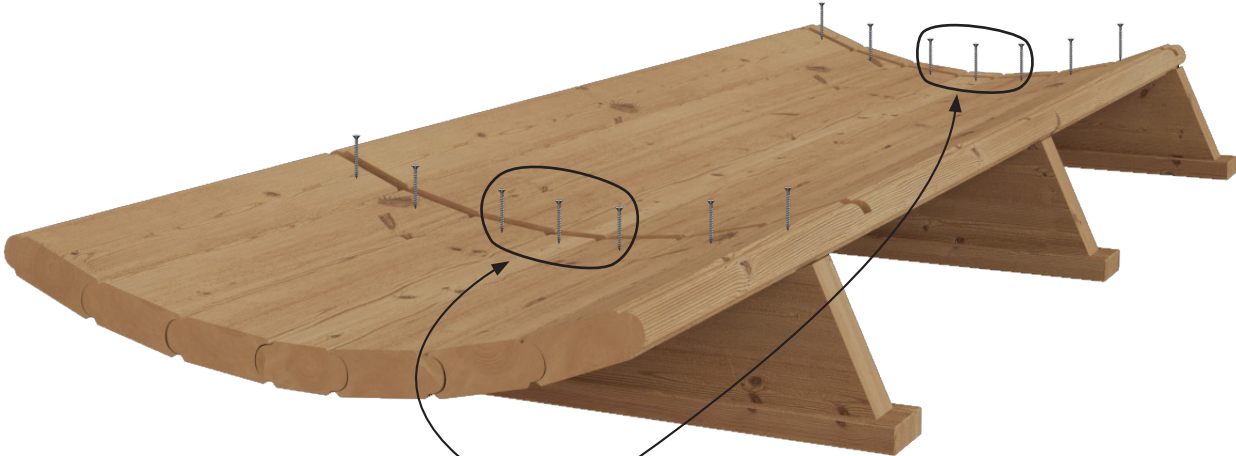

II

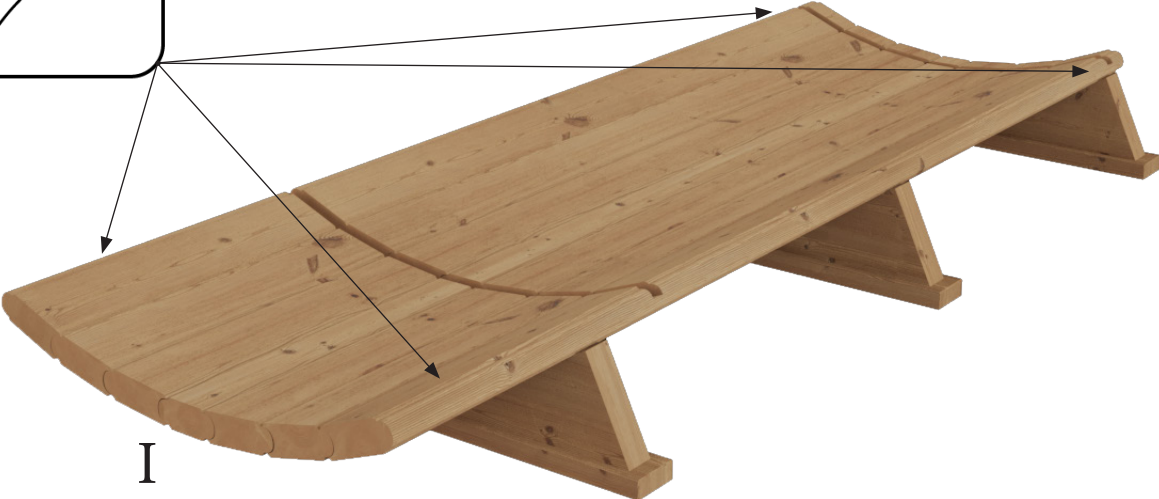
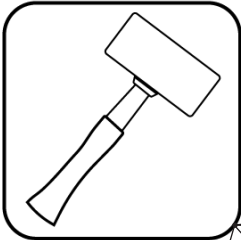

I

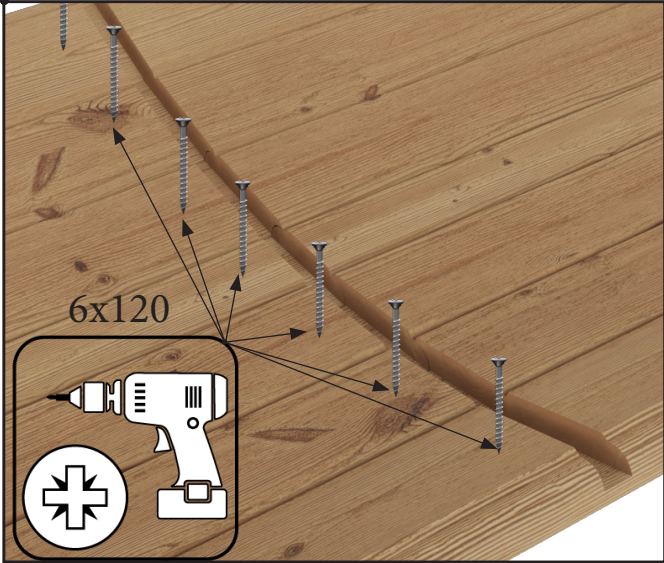

I



II



B



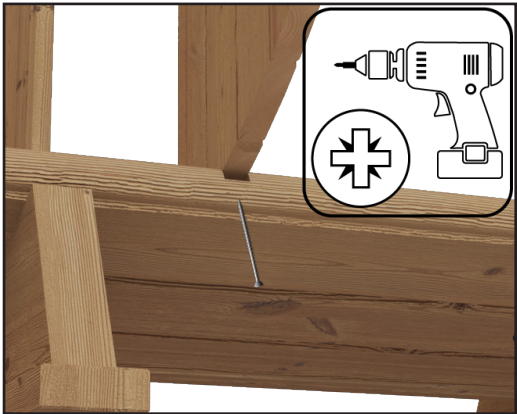
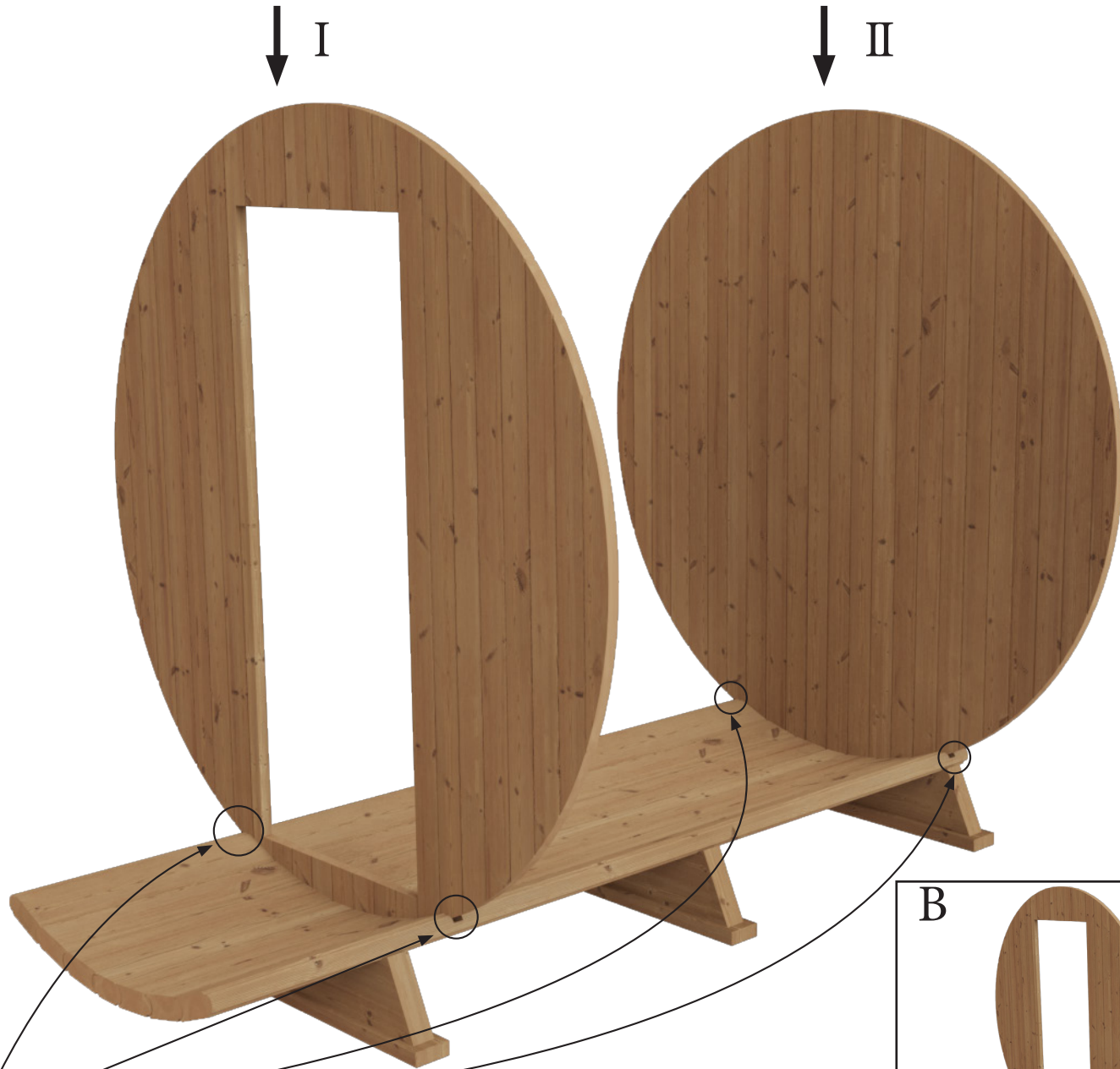
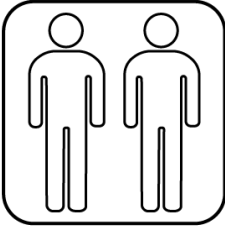

5x90



B

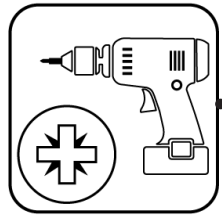

4,2x70

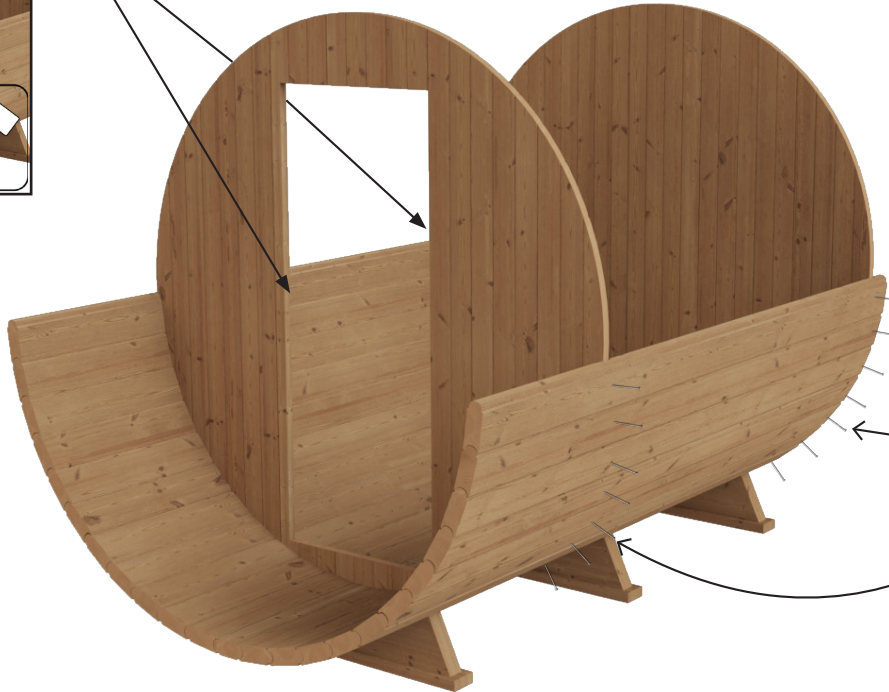
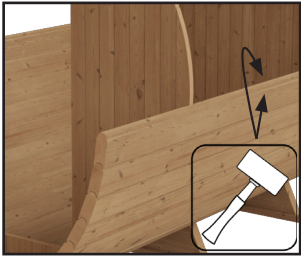
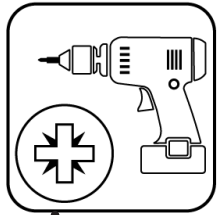
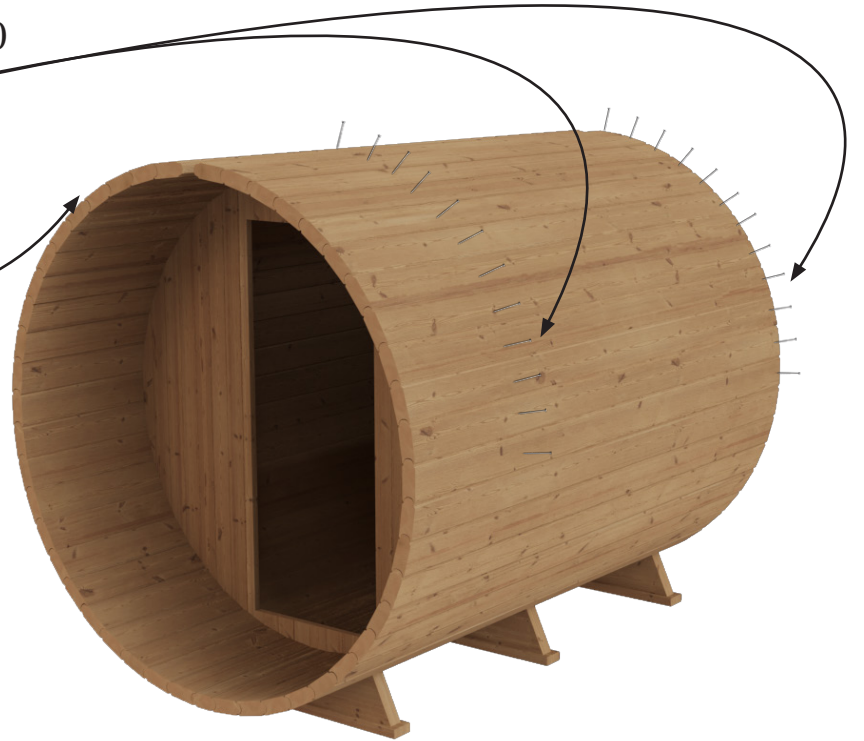

4,2x70

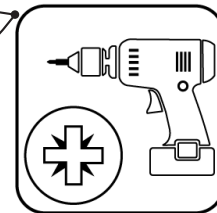

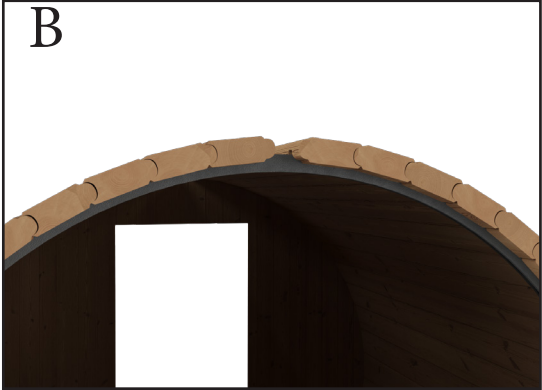
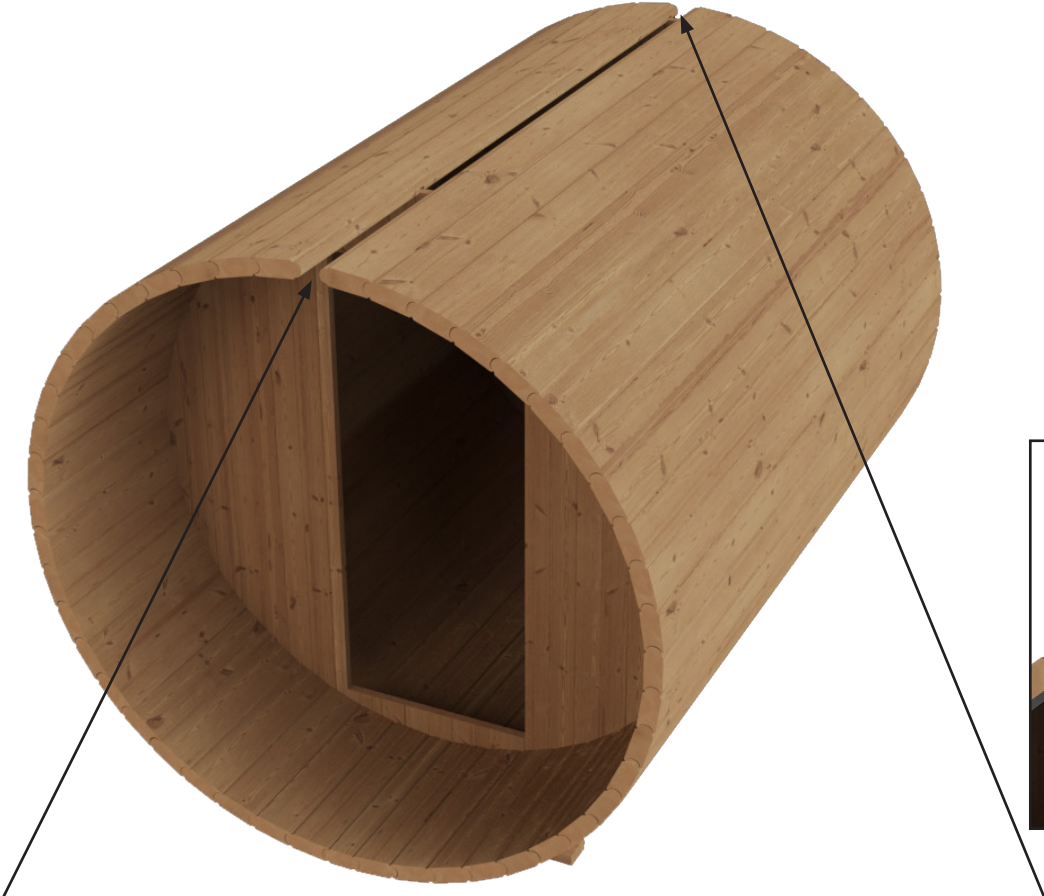

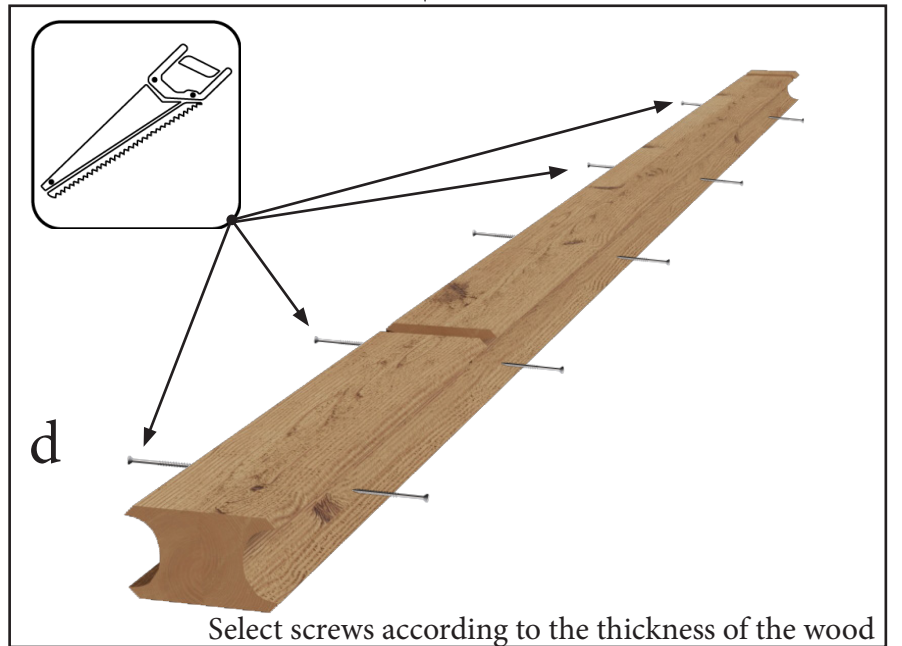
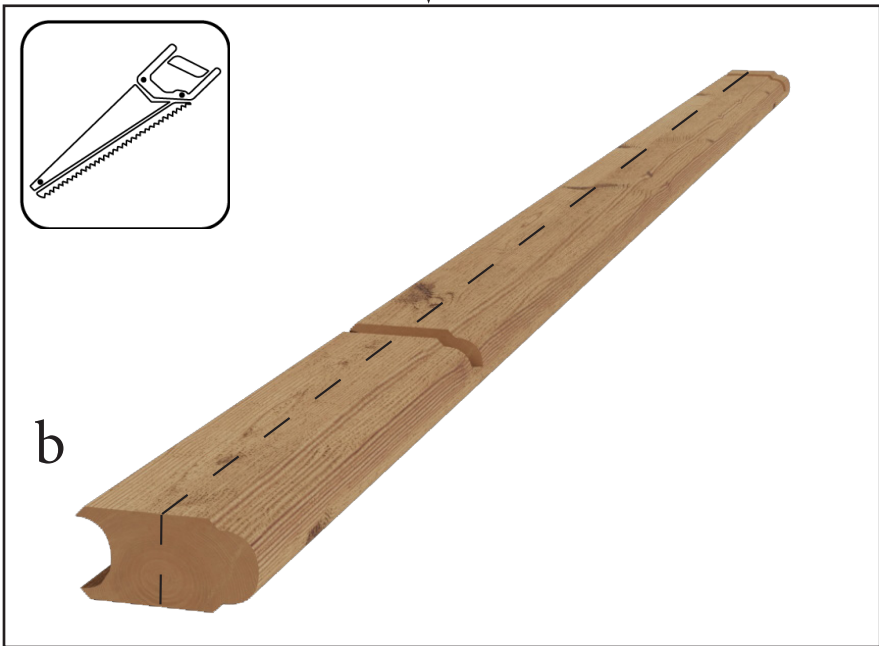
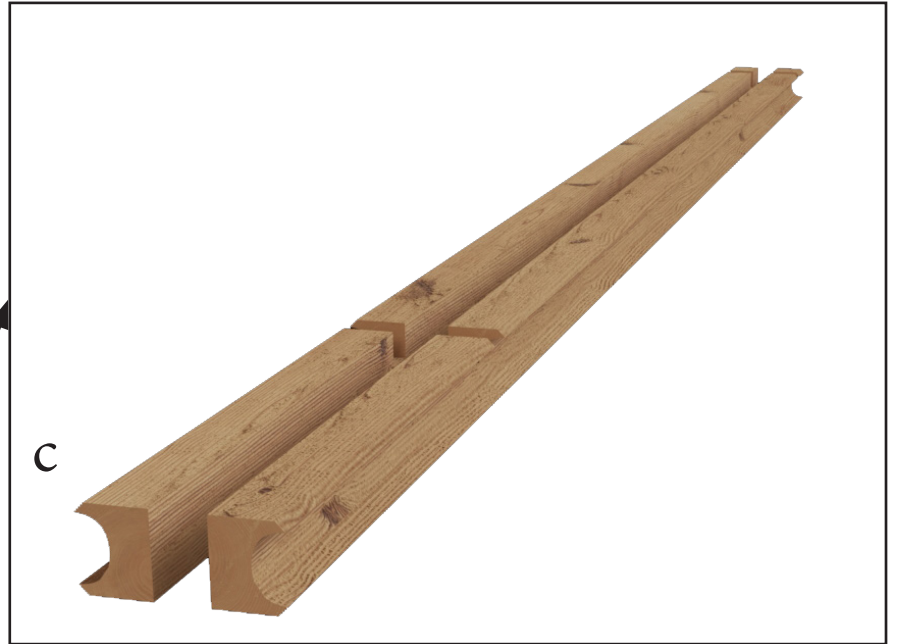
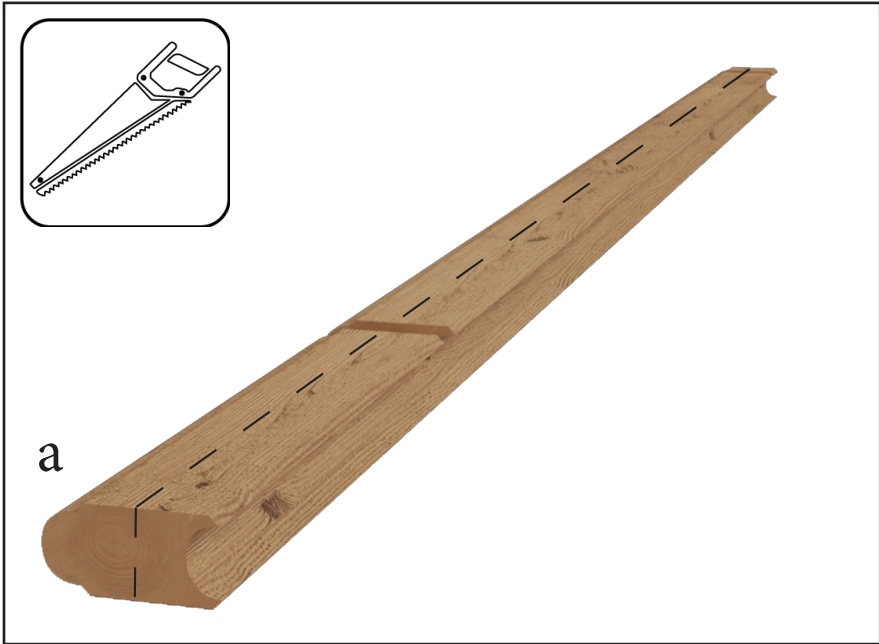

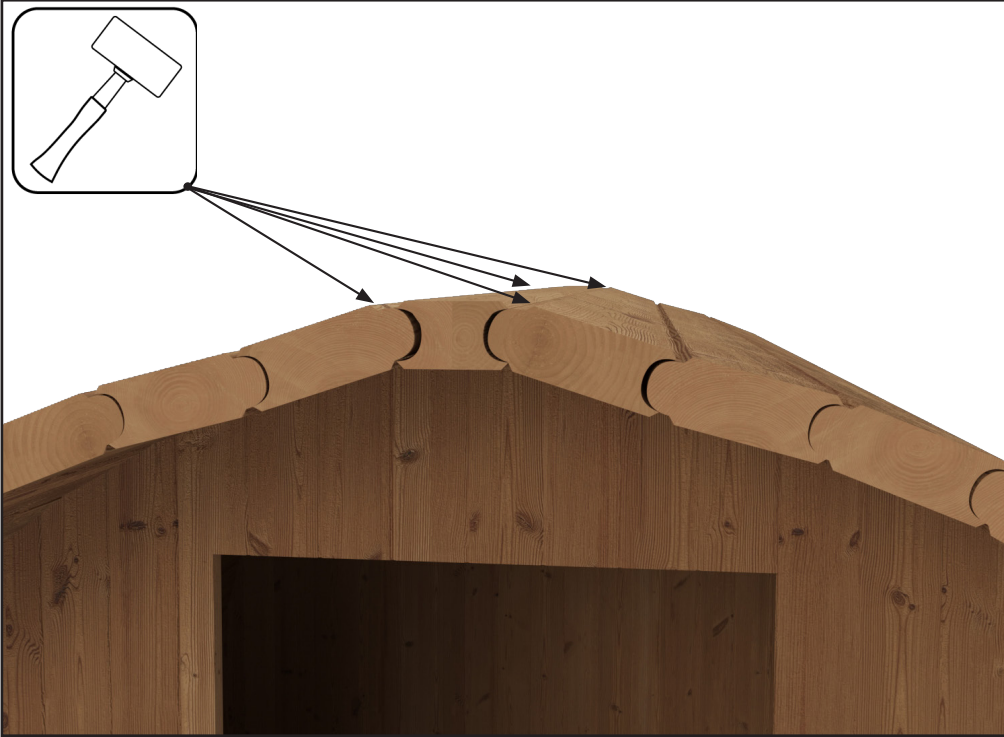

When installing the bands, remove the screws from the housing.

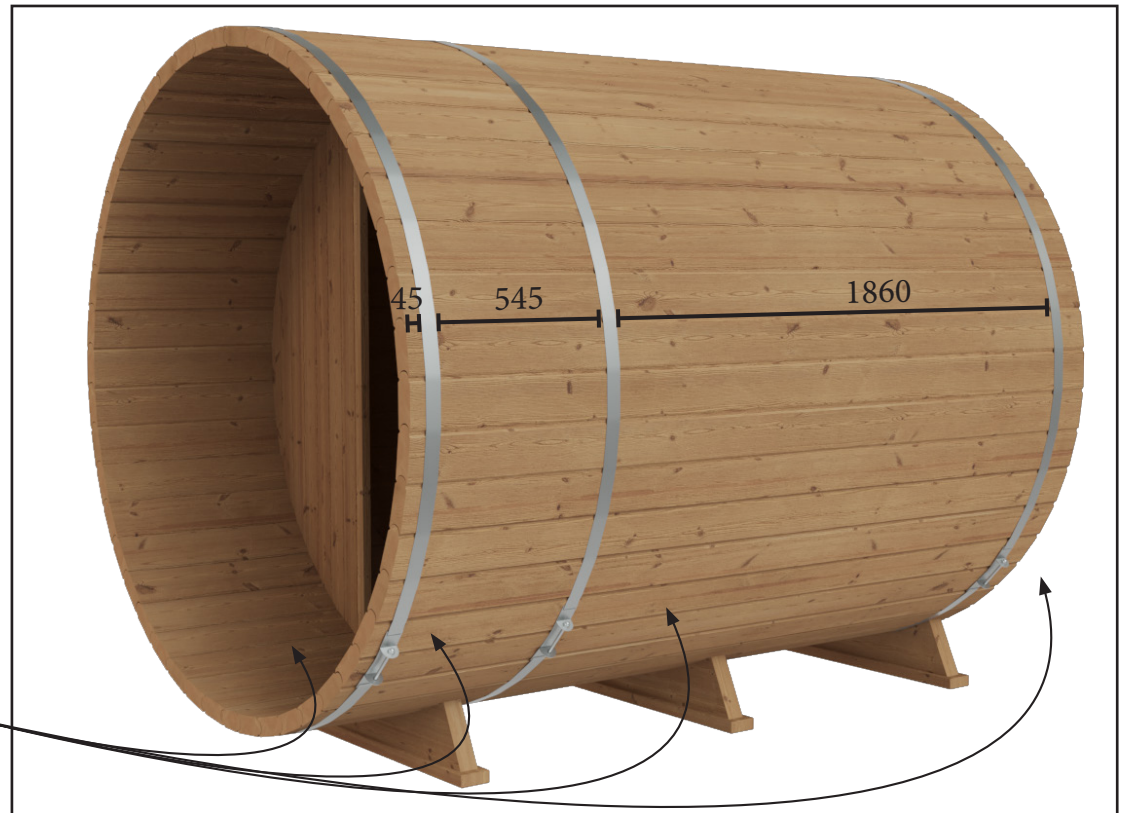
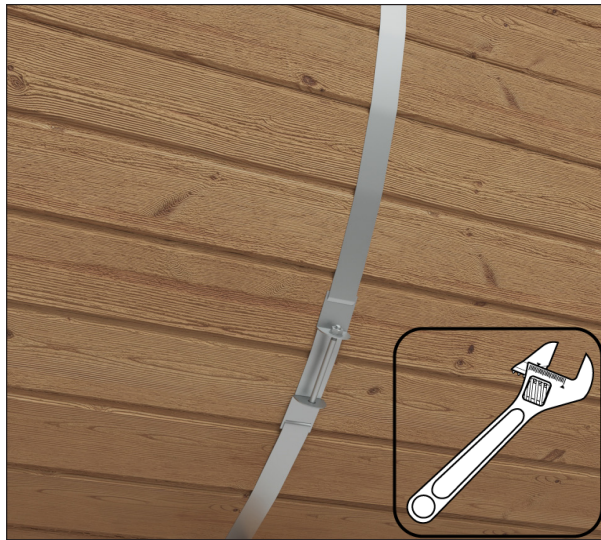
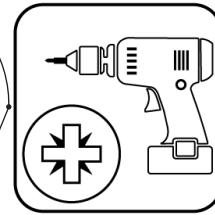
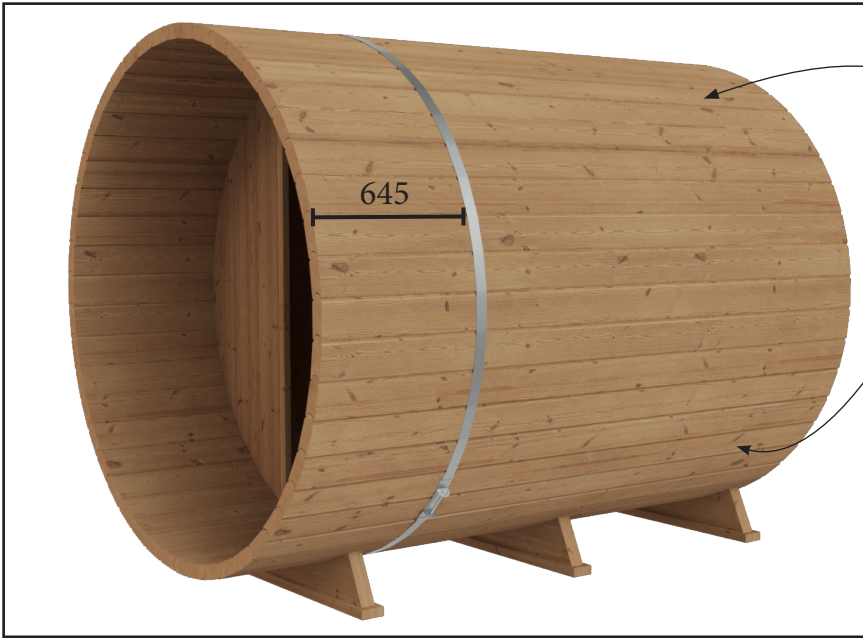

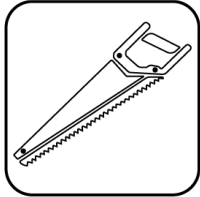

4x40

Screw icon.



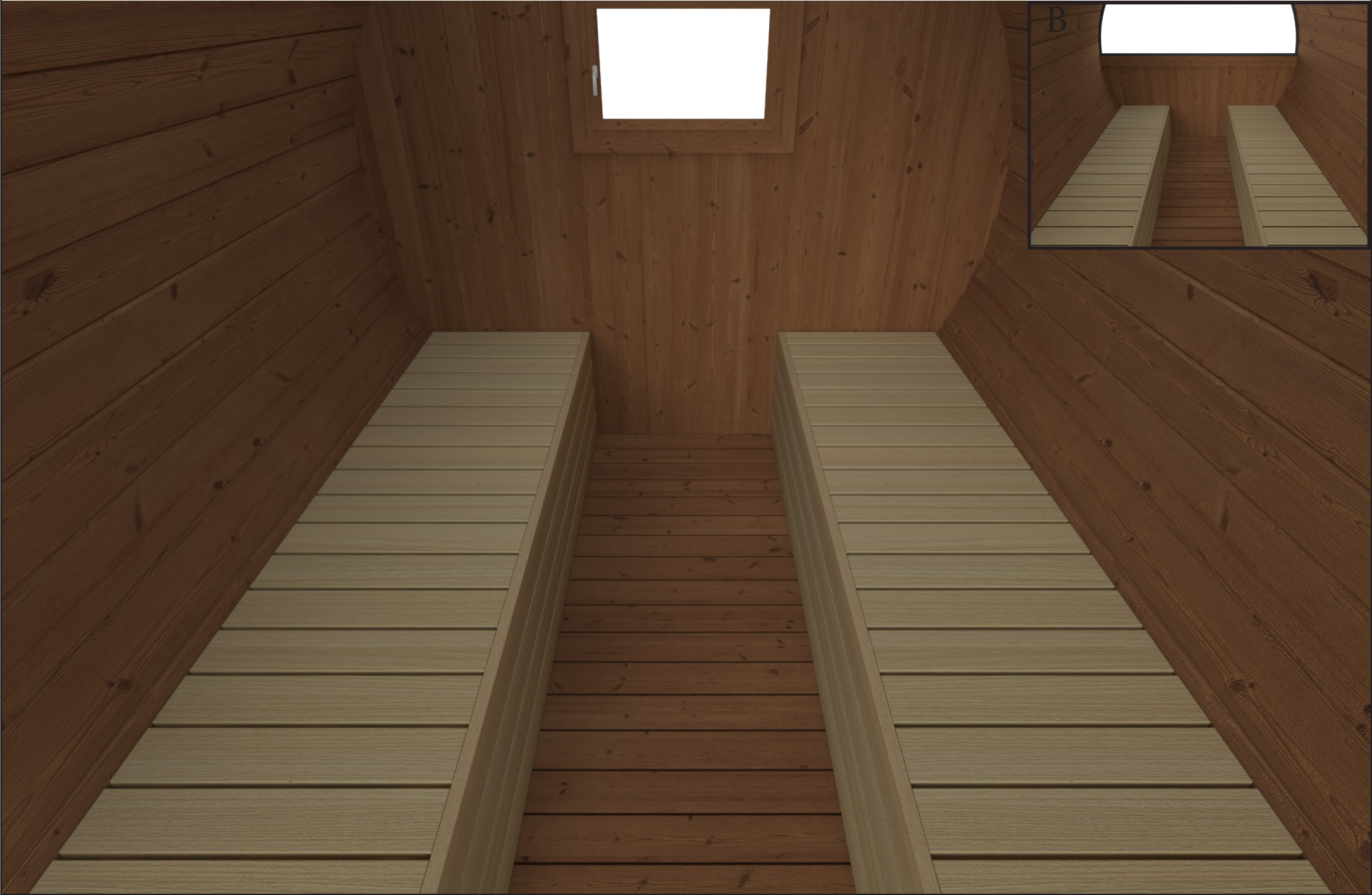

x4

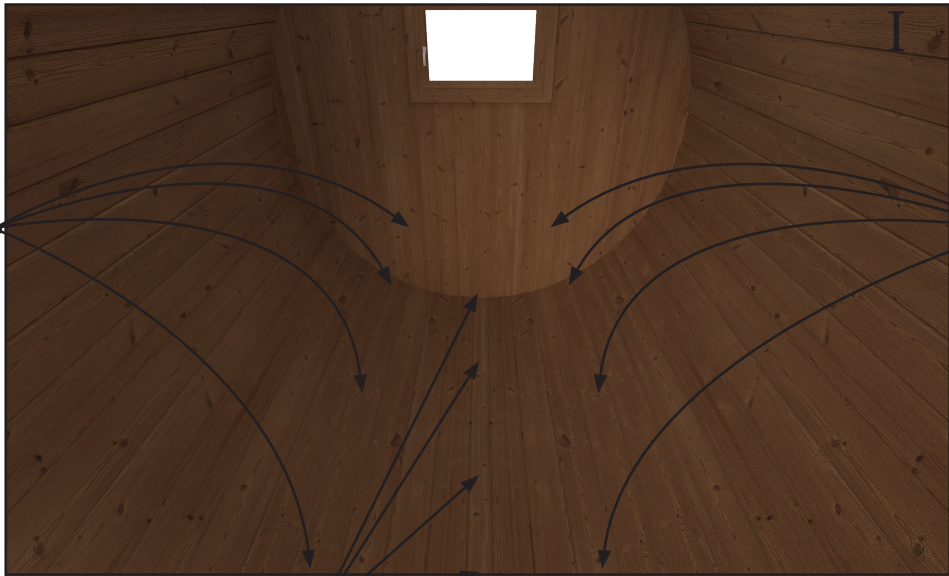
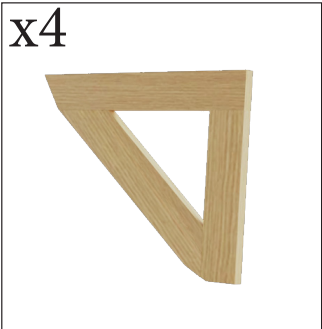

x4

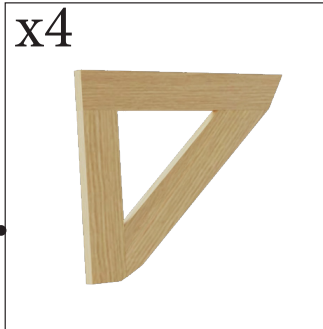

x4

5x100



x2

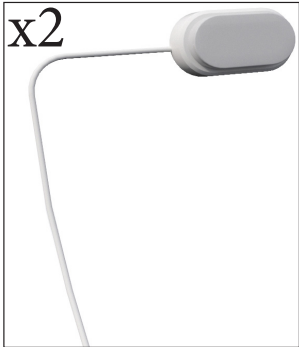

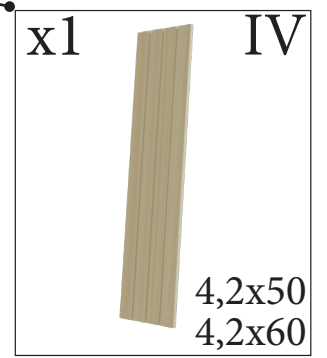
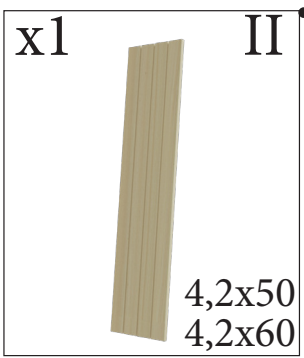
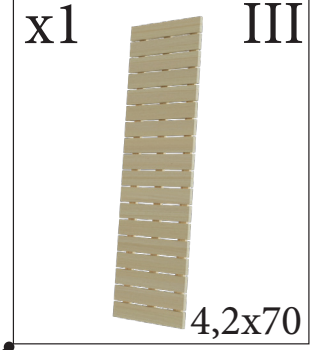
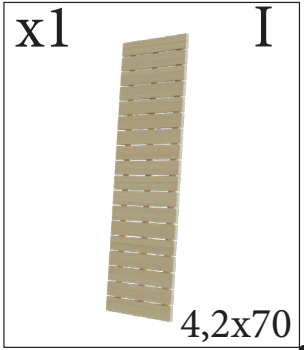

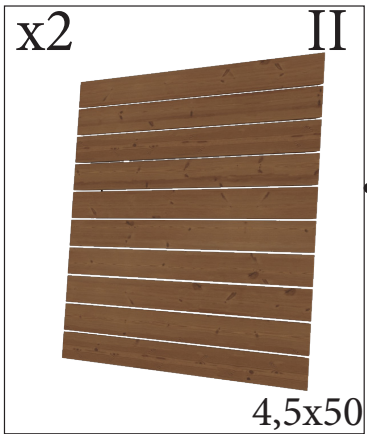



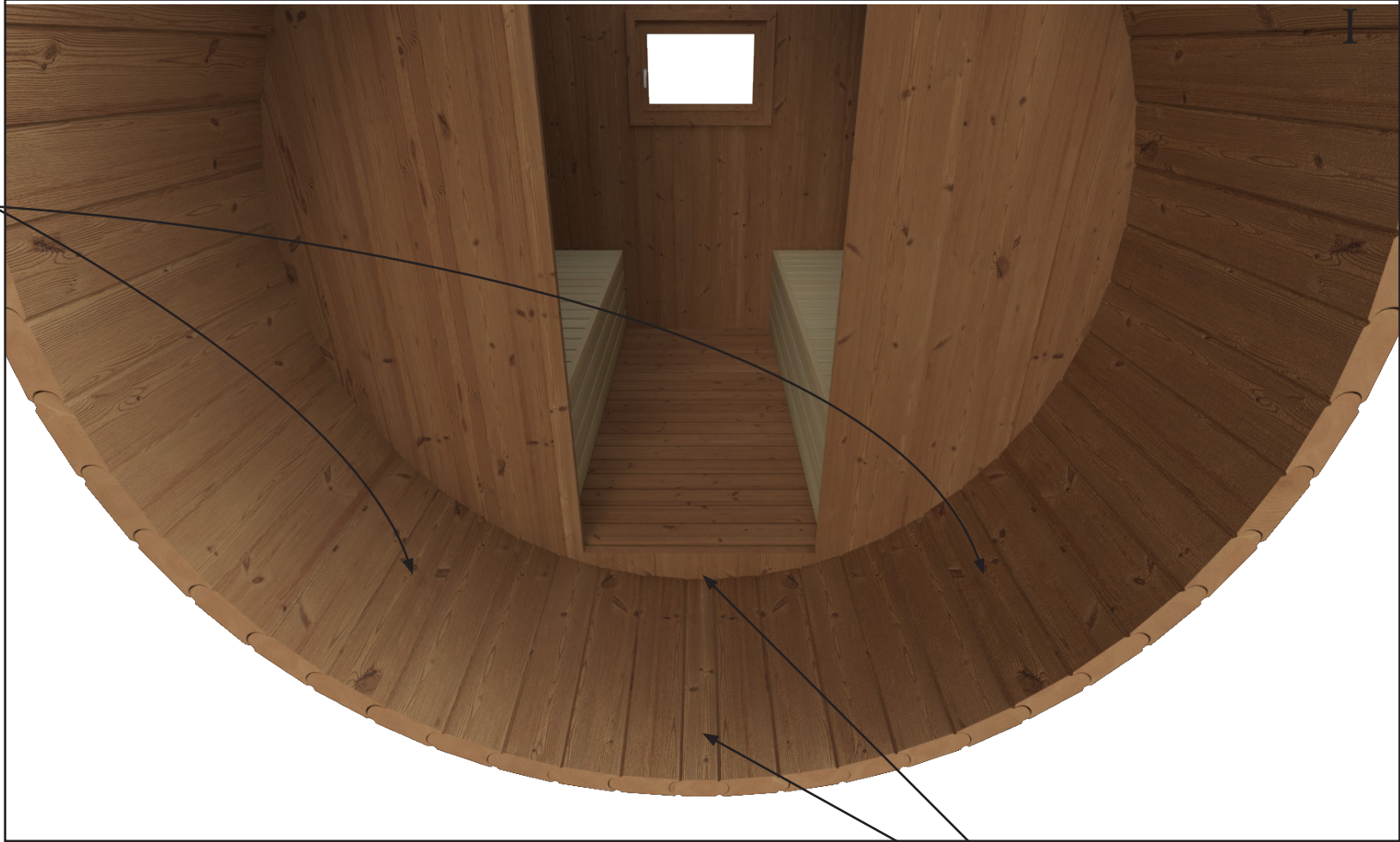
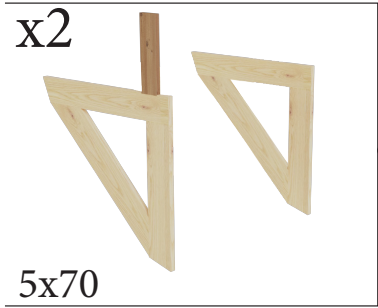

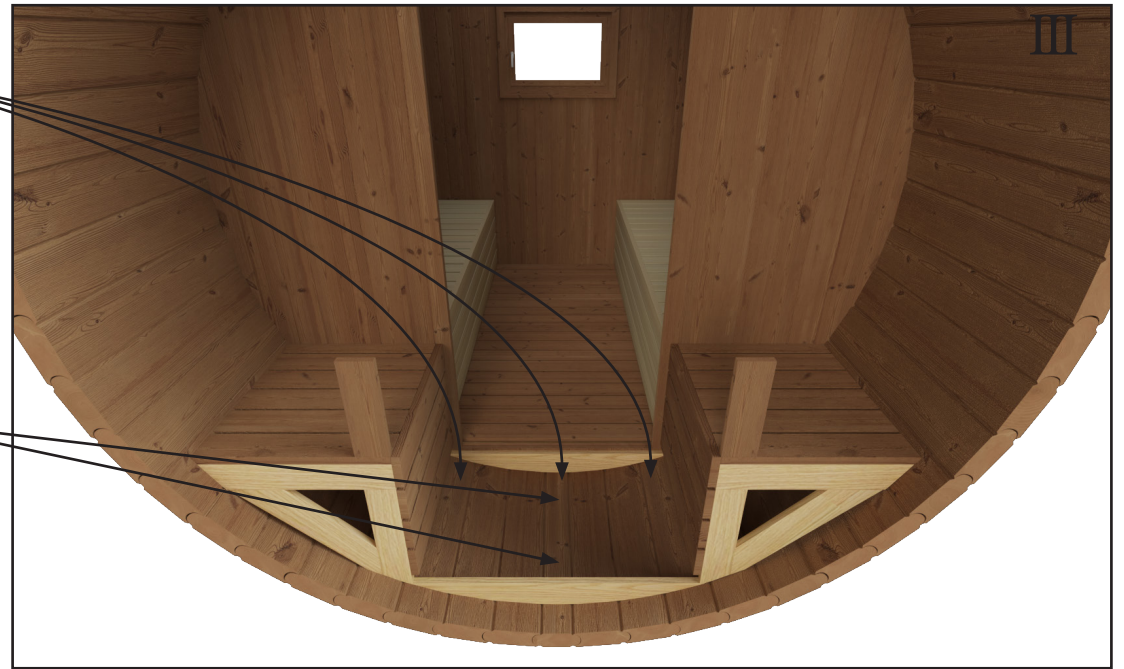
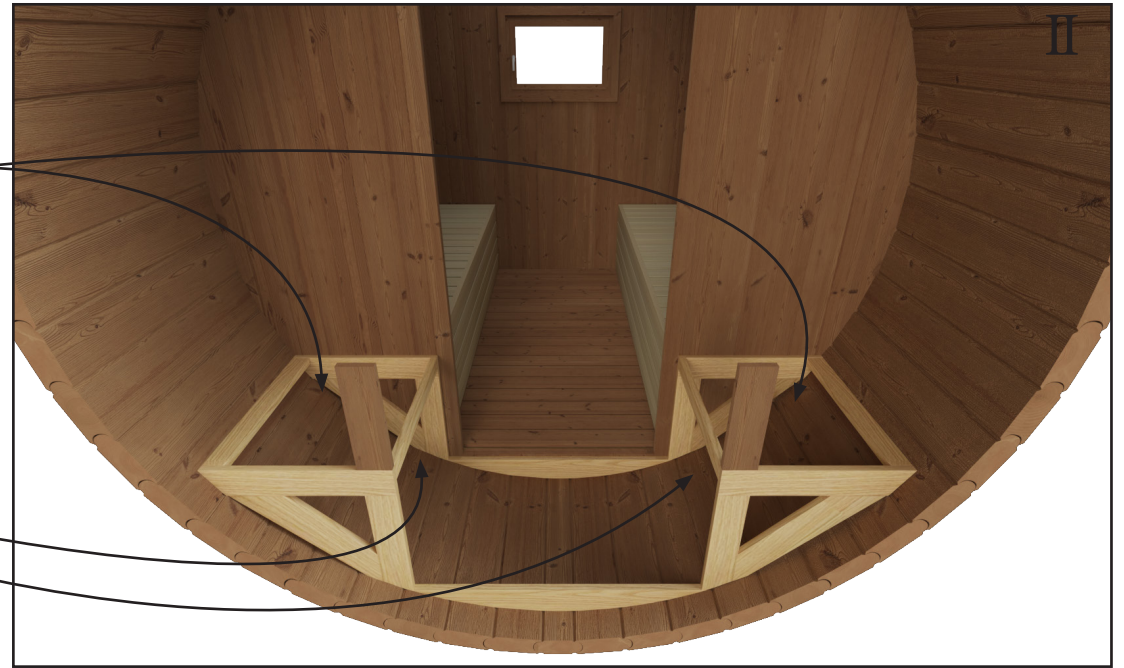
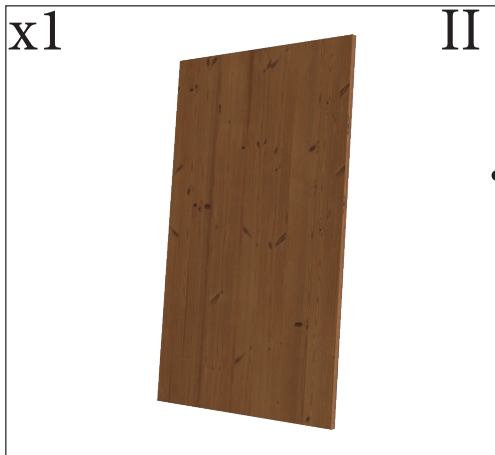
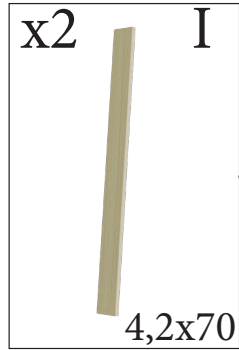
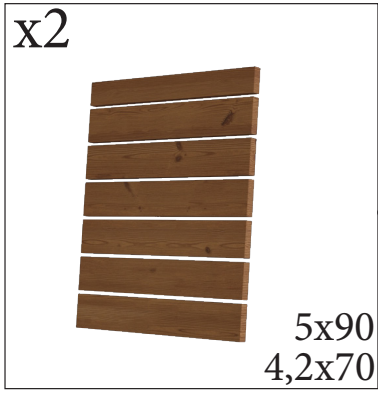
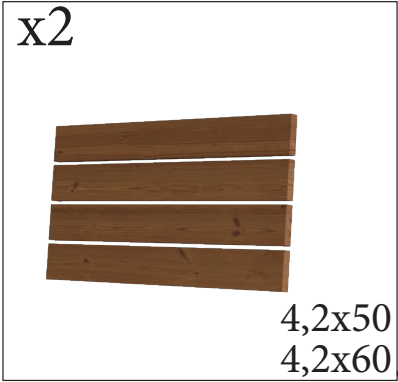

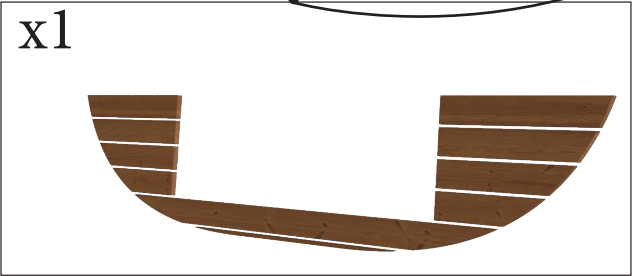

On the terrace armrest, fasten a screw from each side of the band.

